



melba swintex



THE QUEEN'S AWARDS
FOR ENTERPRISE:
INTERNATIONAL TRADE
2019



Custom Mouldings is a service that can help & guide you to bring your **Product** to market.

PRODUCTS MANUFACTURED FROM 100% RECYCLABLE MATERIALS

 100% RECYCLED SIGNS	 100% RECYCLED 1PC CONES	 100% RECYCLED BASES
 60% RECYCLED 2PC CONES	 40% RECYCLED TRENCH COVERS	 20% RECYCLED BARRIERS

ALONG-STANDING **HISTORY & RECYCLING** commitment

350 TONNE of **PLASTIC** is RECYCLED each week

CLOSED LOOP RECYCLING
Turn unwanted products into **NEW**

bsi ISO 9001 Quality Management
FM 673547

ISO 9001 CERTIFIED
Striving to **meet & surpass** Customer requirements



Product Design & Mould Design



Sustainable Materials that are Completely Recyclable

Rapid Prototyping & In-House Testing

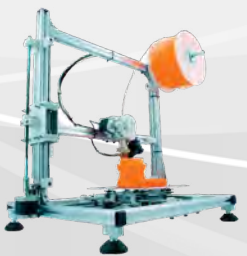

Contents



General

[About](#) [02](#)



Cones

[Bigfoot](#) [04](#)
[Mastercone](#) [05](#)
[Starlite](#) [06](#)
[MPL](#) [07](#)
[Kingkone](#) [08](#)
[Minisign](#) [09](#)
[3 Sided Bollard](#) [09](#)



Barriers

[Olympic](#) [12](#)
[Vision](#) [13](#)
[Master \(Stacca\)](#) [14](#)
[Tuff](#) [15](#)
[Gate](#) [16](#)
[EuroVision](#) [17](#)
[Thor/Hammer](#) [18](#)
[1m Stacca](#) [19](#)
[Utility](#) [20](#)
[the Postman](#) [21](#)



Separators

[Road Runner](#) [24](#)
[HOG600](#) [25](#)
[Buddha](#) [26](#)
[WonderWall™](#) [27](#)
[Mini-DoubleTop](#) [28](#)
[DoubleTop](#) [29](#)



Event Management

[Boss Hog](#) [31](#)
[Boss](#) [32](#)



Signs

[Q-Sign](#) [35](#)
[Q-Sign Supplementary Plate](#) [36](#)
[Q-Frame](#) [37](#)
[Hangman](#) [38](#)



Footway Boards

[Hawk Tuff Trench](#) [40](#)
[Hawk Tuff Tread](#) [41](#)
[Driveway Board](#) [42](#)



Cable Covers

[Cable Covers](#) [44](#)



Cylinders

[Swinbac](#) [46](#)
[Flexi Cylinder](#) [47](#)
[Kingpin](#) [48](#)
[Ariane Twist-Lock](#) [49](#)
[Phoenix](#) [50](#)



Ramps

[Melba](#) [52](#)
[Kerb Buddy](#) [53](#)
[Right Ramp](#) [54](#)
[Hose Cover](#) [55](#)
[Access](#) [56](#)



Bases

[Fence Foot MKII](#) [58](#)
[18kg Multifit](#) [58](#)
[15kg Footplate](#) [59](#)
[25kg Footplate](#) [59](#)
[28kg Footplate](#) [60](#)
[KG-Base](#) [60](#)
[Stepped Weight](#) [61](#)
[Anti-Trip Foot](#) [62](#)
[Standard Foot](#) [62](#)
[Tuff-AT Foot](#) [62](#)
[Tuff Foot](#) [62](#)
[Panolest Base](#) [63](#)
[Defiance Base](#) [63](#)
[Cats Eye Base](#) [63](#)
[Q-Weight](#) [63](#)
[Road Rock](#) [64](#)



Litter Bins

[Darcy](#) [67](#)
[Falcon](#) [67](#)
[Merlin](#) [67](#)
[Pickwick](#) [67](#)
[Copperfield](#) [67](#)
[Osprey](#) [69](#)
[Nickleby](#) [69](#)
[Doggy Bin](#) [69](#)



Miscellaneous

[Bin Lid](#) [70](#)
[Buckets](#) [71](#)
[Barrier Wind Resistance](#) [72](#)
[Q-Sign Wind Resistance](#) [77](#)

How to Find Us

Address: Stubbins Vale Mill
 Stubbins Vale Road
 Ramsbottom
 BLO ONT

Telephone: +44 (0)161 761 4933

Web: www.melbaswintex.com

Disclaimer

The contents and information contained in this brochure are intended for general marketing purposes only. Melba Swintex reserves the right to alter specifications and designs without prior notice. All weights are an approximate figure rounded to the nearest second decimal place.

About

Our Mission

TO BE THE WORLD **LEADING** SUPPLIER OF
TEMPORARY TRAFFIC MANAGEMENT EQUIPMENT
BY **EXCEEDING** OUR CUSTOMERS EXPECTATIONS
IN QUALITY, DELIVERY AND CONTINUOUS IMPROVEMENT

Who We Are

Melba Swintex is the world's leading manufacturer of temporary traffic management products. With a range that complies with all national and international standards.







The management has a wealth of knowledge and experience in the design and manufacture of traffic products, and also works together with our partners to provide customised products for the industry. Melba Swintex is proud of it's record in designing and producing innovative products to meet industry standards.

The company perform a number of manufacturing processes that include compression moulding, blow moulding, injection moulding, rotational moulding, the manufacture of reflective sheeting, and processes which recycle a variety of waste plastics into new products.

As with most progressive companies, we have a solid commitment to the environment. We recycle 10,000 tonnes of material in the manufacturing of our products.

Melba Swintex has built it's reputation on the quality of it's products and services, which our customers have come to expect. Our aim is to not only maintain this reputation, but to build on it.

Key

-  - Product conforms to British Standards.
-  - Manufactured from materials that can be recycled.
-  - Various colours available to order (minimum order quantity required).
-  - Product is currently in the process of patent approval, or approved.
-  - Fitted with high performance prismatic Starlux[®] pocketed sleeve.
-  - Tested & Kitemarked by the British Standards Institution.



Cones

Bigfoot

Description:

The Bigfoot Cone is long established as the industry leader for Traffic Cones. It was the first two piece cone to be manufactured, and is the benchmark for Traffic Cones all over the world. The cone base is manufactured from recycled material, and can be coloured on request.

Features:

- Blow moulded top with easy grip access.
- 100% thermoplastic recyclable base with anti-slip feature.
- Fitted with high performance prismatic Starlux® pocketed sleeve, offering superb daylight luminance and night time reflectivity.
- Bases & centres can also be embossed and/or coloured.

Standards:

- Conforms to requirements of **BSEN13422**
- Chapter 8 - The Traffic Signs Manual
- The Red Book 2013
- Traffic Signs Regulations & General Directions



500 mm

750 mm

1 m

Size 2:

Our 750mm Bigfoot Cone is also available in a Recessed, Straight Sided, or Lightweight Base version.



Height:	500 mm
Weight:	2.10 kg
Height:	750 mm
Weight:	4.60 kg
Height:	1000 mm
Weight:	8.10 kg

*All weights are approximate

The information given on these sheets is typical of the product depicted it must not be interpreted as a guarantee of individual product performance and/or characteristics. We reserve the right to alter specifications and designs without prior notice. All measurements are in millimetres (mm)



Mastercone

Description:

One of the most practical two piece cones on the market. The Mastercone has been dominant on the roads for many years. Incorporating the Melba Swintex high performance prismatic Starlux® sleeve, the Mastercone is highly visible to all motorists.

Features:

- Blow moulded top with easy grip access.
- 100% thermoplastic recyclable PVC base with anti-slip feature.
- Fitted with high performance Starlux® pocketed prismatic sleeve, offering superb daylight luminance and night time reflectivity.
- Bases & centres can also be embossed and coloured.
- Centre manufactured from recyclable LDPE and HDPE combined.

Standards:

- Conforms to requirements of **BSEN13422**
- Chapter 8 - The Traffic Signs Manual
- The Red Book 2013
- Traffic Signs Regulations & General Directions



500 mm

750 mm

1 m



Height:	500 mm
Weight:	2.25 kg
Height:	750 mm
Weight:	4.40 kg
Height:	1000 mm
Weight:	7.50 kg

*All weights are approximate

The information given on these sheets is typical of the product depicted it must not be interpreted as a guarantee of individual product performance and/or characteristics. We reserve the right to alter specifications and designs without prior notice. All measurements are in millimetres (mm)



Starlite

Description:

The Starlite cone is a two piece cone, with it's centre manufactured from virgin HDPE, and base from recycled PVC. The cone is 100% recyclable and is fitted with the Melba Swintex high performance prismatic Starlux[®] sleeve.

Features:

- Blow moulded top with easy grip access.
- 100% thermoplastic recyclable base with anti-slip feature.
- Fitted with high performance Starlux[®] pocketed prismatic sleeve, offering superb daylight luminance and night time reflectivity.
- Bases & centres can also be embossed and coloured.

Standards:

- Conforms to requirements of **BSEN13422**
- Chapter 8 - The Traffic Signs Manual
- The Red Book 2013
- Traffic Signs Regulations & General Directions



750 mm



1m



Height:	750mm
Weight:	4.15kg
Height:	1000mm
Weight:	6.50kg

*All weights are approximate

The information given on these sheets is typical of the product depicted it must not be interpreted as a guarantee of individual product performance and/or characteristics. We reserve the right to alter specifications and designs without prior notice. All measurements are in millimetres (mm)



MPL

Description:

The MPL is a cost effective one piece cone, manufactured from 100% recycled thermoplastic, which is recyclable, making the MPL range a completely environmentally friendly cone family. The base can be coloured to suit, and/or embossed with a company logo.

Standards:

- Sleeve Conforms to requirements of **BSEN13422**
- Chapter 8 - The Traffic Signs Manual
- The Red Book 2013
- Traffic Signs Regulations & General Directions



500 mm



750 mm



No Waiting



Height:	500 mm
Weight:	3.00 kg
Height:	750 mm
Weight:	5.00 kg

*All weights are approximate

The information given on these sheets is typical of the product depicted it must not be interpreted as a guarantee of individual product performance and/or characteristics. We reserve the right to alter specifications and designs without prior notice. All measurements are in millimetres (mm)



Kingkone

Description:

The Kingkone comes in two types; a two piece blow moulded 460 mm cone, or a one piece, sand weighted, blow moulded 750 mm cone.

Kingkone 460 mm:

- Two-piece blow moulded cone, with recyclable PVC base.

Kingkone 750 mm:

- Extra strong sand ballast retention.
- Bind free stacking.

Standards:

- Conforms to requirements of **BSEN13422**
- Chapter 8 - The Traffic Signs Manual
- The Red Book 2013
- Traffic Signs Regulations & General Directions



460mm

750mm



Height:	460 mm
Weight:	2.75 kg
Height:	750 mm
Weight:	5.50 kg

*All weights are approximate

The information given on these sheets is typical of the product depicted it must not be interpreted as a guarantee of individual product performance and/or characteristics. We reserve the right to alter specifications and designs without prior notice. All measurements are in millimetres (mm)



Minisign

Description:



The Minisign is a two part cone that displays a unique shape. The top is manufactured from LDPE, and the base is manufactured from 100% recycled PVC.

Options:

No Waiting/Police No Waiting. Embossing service available.

Standards:

- The Red Book 2013
- Traffic Signs Regulations & General Directions

Height:	480 mm
Width:	330 mm
Weight:	3.80 kg



3 Sided Bollard

Description:



The tough 3 Sided Bollard is the ideal cone for implementing parking restrictions.

Features:

- Injection moulded from recycled PVC.
- High-in-strength and durable.
- Simple to stack.

Standards:

- Chapter 8 - The Traffic Signs Manual
- The Red Book 2013
- Traffic Signs Regulations & General Directions

Height:	500 mm
Width:	390 mm
Weight:	3.85 kg



*All weights are approximate

The information given on these sheets is typical of the product depicted it must not be interpreted as a guarantee of individual product performance and/or characteristics. We reserve the right to alter specifications and designs without prior notice. All measurements are in millimetres (mm)



Cone Customisation

Coloured Conical

Have the Cone Centre manufactured in the colour of your choice - just provide the colour!*



Sleeve Printing

Various coloured sleeves available, as well as custom printing of text and logos directly onto the sleeve.



Embossed Conical & Base

Emboss the Centre and/or Base with your choice of text/logo for Security & Brand Identity*



Coloured Base

Have your base coloured in a single colour to match your brand.*



KM649097

The only Traffic Cone collection on the market with the Kitemark™ stamp of approval.

*Minimum order quantities apply

The information given on these sheets is typical of the product depicted it must not be interpreted as a guarantee of individual product performance and/or characteristics. We reserve the right to alter specifications and designs without prior notice. All measurements are in millimetres (mm)



Barriers



Olympic

Description:

The Olympic Barrier offers the complete versatile system for utility and construction applications with hinged side wings designed to rotate and self lock at every 90°. This unique feature allows contractors to create configurations to protect temporary pathway excavations and road works of all kinds.

Features:

- Side wings fold - Easy transport where space is limited.
- Side wings rotate and lock at 90°.
- Fixing area for courtesy board.
- Sliding linking clips to extend barrier.
- Feet can swivel 360°.
- Available in various colours.
- Side wings can be used as door access.

Standards:

- Conforms to requirements of **BSEN8442**
- Reflectivity requirements of **BSEN12899-1**
- Chapter 8 - The Traffic Signs Manual
- The Red Book 2013
- Traffic Signs Regulations & General Directions



Boxed

Wings Open

Anti-Trip Feet

Please see the back for Wind Resistance



Height:	1020 mm
Width:	2000 mm or 1250 mm
Depth:	50 mm
Weight:	10.00 kg Anti-Trip Foot 11.40 kg Standard Foot 15.40 kg Tuff-AT Foot 15.80 kg Tuff Foot

*All weights are approximate

The information given on these sheets is typical of the product depicted it must not be interpreted as a guarantee of individual product performance and/or characteristics. We reserve the right to alter specifications and designs without prior notice. All measurements are in millimetres (mm)



Vision

Description:

The Vision Barrier can connect to either itself or other existing barriers using the various attachment methods on offer. Reflective strips on the spindles allow increased visibility.

Features:

- Manufactured from virgin HDPE.
- 600 x 450 sign facility.
- Highly reflective sleeves (360°) on two vertical spindles for improved visibility.
- Q-Clip support for barrier to barrier connection.
- Hook & Eye connection to other barriers.
- Compatible with Master & Gate barriers.
- Customer identification may be embossed into Barrier body.
- Available in other colours upon request.

Standards:

- Conforms to requirements of **BSEN8442**
- Reflectivity requirements of **BSEN12899-1**
- Chapter 8 - The Traffic Signs Manual
- The Red Book 2013
- Traffic Signs Regulations & General Directions

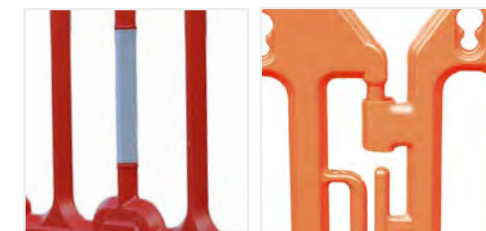

Spindle Reflective

Hook & Eye

Please see the back for Wind Resistance



Height:	1000 mm
Width:	2000 mm
Depth:	50 mm
Weight:	09.10 kg Anti-Trip Foot 10.50 kg Standard Foot 14.50 kg Tuff-AT Foot 14.90 kg Tuff Foot

*All weights are approximate

The information given on these sheets is typical of the product depicted it must not be interpreted as a guarantee of individual product performance and/or characteristics. We reserve the right to alter specifications and designs without prior notice. All measurements are in millimetres (mm)



Master (Stacca)

Description:

The Master Barrier is our most successful barrier, with its high tensile strength and lightness, it makes it the perfect barrier for any form of utility works. The addition of anti-trip feet allow pathways to be kept clear for pedestrian access.

Features:

- Free standing with 360° swivel feet.
- Free from screws and rivets.
- Moulded in orange as standard, but can be coloured to suit.
- Feet can be coloured to suit.
- Barrier to barrier connection is quick and easy for use on uneven ground.
- Information sign can be attached.
- Reflective strip at top and bottom.
- Company identification can be embossed.
- Manufactured from virgin HDPE.
- Bottom reflective strip if requested.

Standards:

- Conforms to requirements of **BSEN8442**
- Reflectivity requirements of **BSEN12899-1**
- Chapter 8 - The Traffic Signs Manual
- The Red Book 2013
- Traffic Signs Regulations & General Directions



Anti-Trip Feet

Standard Foot

Please see the back for Wind Resistance



Height:	1000 mm
Width:	2000 mm
Depth:	50 mm
Weight:	09.10 kg Anti-Trip Foot 10.50 kg Standard Foot

*All weights are approximate

The information given on these sheets is typical of the product depicted it must not be interpreted as a guarantee of individual product performance and/or characteristics. We reserve the right to alter specifications and designs without prior notice. All measurements are in millimetres (mm)



Tuff Barrier

Description:

The Tuff Barrier is a stylish, tough and durable barrier. Incorporating the Q-Clip, the barriers connect together in a linear row. When combined with the Road Rock, the barriers become highly wind resistant.

Features:

- Manufactured from virgin HDPE.
- 600 x 450 sign facility.
- Moulded in orange as standard, but can be coloured to suit.
- Q-Clip for barrier to barrier connection.
- Barrier may be coloured.
- Compatible with Master barrier.
- Customer identification can be embossed.

Standards:

- Conforms to requirements of **BSEN8442**
- Reflectivity requirements of **BSEN12899-1**
- Chapter 8 - The Traffic Signs Manual
- The Red Book 2013
- Traffic Signs Regulations & General Directions



Spindle Reflective

Anti-Trip Feet

Please see the back for Wind Resistance



Height:	1000 mm
Width:	2000 mm
Depth:	50 mm
Weight:	09.10 kg Anti-Trip Foot 10.50 kg Standard Foot 14.50 kg Tuff-AT Foot 14.90 kg Tuff Foot

*All weights are approximate

The information given on these sheets is typical of the product depicted it must not be interpreted as a guarantee of individual product performance and/or characteristics. We reserve the right to alter specifications and designs without prior notice. All measurements are in millimetres (mm)



Gate

Description:

The Gate is one of the most popular blow moulded barriers. This superior blow moulded HDPE barrier offers superb quality at a low life cost.

Features:

- Incredible strength and durability.
- Free standing with 360° swivel feet.
- Free from screws and rivets.
- Stacks in 50 mm (2 inch) with location (40 per pallet).
- Moulded in orange as standard, but can be coloured to suit.
- Coloured feet if desired.
- A moulded lamp connector.
- Barrier to barrier connection is quick and easy to use on uneven ground.
- Manufactured in High Density Polyethylene.
- Company identification can be embossed.

Standards:

- Conforms to requirements of **BSEN8442**
- Reflectivity requirements of **BSEN12899-1**
- Chapter 8 - The Traffic Signs Manual
- The Red Book 2013
- Traffic Signs Regulations & General Directions

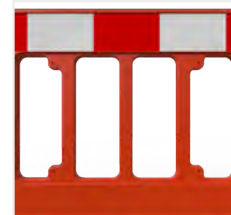

Courtesy Sign



Anti-Trip Feet

Please see the back for Wind Resistance

 Recyclable Customise	Height:	1000 mm
	Width:	2000 mm
	Depth:	50 mm
	Weight:	08.90 kg Anti-Trip Foot 10.30 kg Standard foot

*All weights are approximate

The information given on these sheets is typical of the product depicted it must not be interpreted as a guarantee of individual product performance and/or characteristics. We reserve the right to alter specifications and designs without prior notice. All measurements are in millimetres (mm)



EuroVision

Description:

The EuroVision is an adaptation of the popular Vision Barrier, fitted with a deeper, highly reflective strip for conformance to European Standards.

Features:

- Manufactured from virgin HDPE.
- Q-Clip support for barrier to barrier connection.
- Hook & Eye connection to other barriers.
- Compatible with existing Melba Swintex Barriers.
- Customer identification may be embossed into Barrier body.
- Available in other colours upon request.
- Deeper reflective for European Continent.

Standards:

- Conforms to requirements of **BSEN8442**
- Reflectivity requirements of **BSEN12899-1**
- Chapter 8 - The Traffic Signs Manual
- The Red Book 2013
- Traffic Signs Regulations & General Directions



Connection



Link to Gate



Tuff Foot

 Recyclable Customise	Height:	1000 mm
	Width:	2000 mm
	Depth:	50 mm
	Weight:	09.30 kg Anti-Trip Foot 10.70 kg Standard Foot 14.70 kg Tuff-AT Foot 15.10 kg Tuff Foot

*All weights are approximate

The information given on these sheets is typical of the product depicted it must not be interpreted as a guarantee of individual product performance and/or characteristics. We reserve the right to alter specifications and designs without prior notice. All measurements are in millimetres (mm)



Thor Barrier

Description:

The Thor Barrier is a highly robust and protective Barrier that can be deployed to guide vehicles and pedestrians on to the correct path when required. Over engineered to produce great strength, and almost near to impossible to knock over when used with the 28 kg Footplate.

Features:

- Various locations for a lamp.
- Customer identification can be embossed.
- Can be in corporate colours.
- Facility for a sign.
- Incredibly strong & durable.
- Connected together using the high strength Thor Hook.
- Stacking for ease of transport.
- Steel tubing legs increase strength & stability.
- Work in conjunction with the 28 kg Footplate.
- Deeper Scotchlite & Bottom strip for greater visibility.
- Completely recyclable.
- Manufactured from Virgin HDPE.

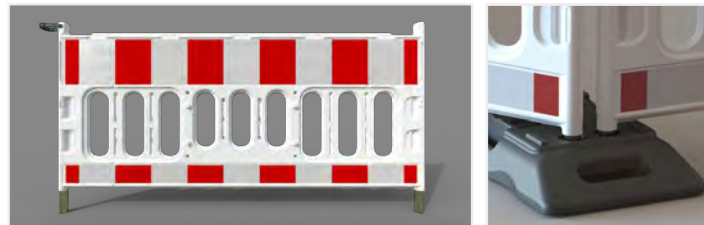

The Hammer

Standards:

- Conforms to requirements of **BSEN8442**
- Reflectivity requirements of **BSEN12899-1**
- The Red Book 2013
- Traffic Signs Regulations & General Directions
- TL Absperschranken 97
- TL-Aufstellvorrichtungen 97
- Conforms to requirements of ZTV-SA

Height:	1060 mm
Width:	2060 mm
Depth:	50 mm
Weight:	9.50 kg



The information given on these sheets is typical of the product depicted it must not be interpreted as a guarantee of individual product performance and/or characteristics. We reserve the right to alter specifications and designs without prior notice. All measurements are in millimetres (mm)



1m Stacca

Description:

The 1m Stacca barrier is both strong, and light in weight, and is ideal to use for utility based works. The addition of anti-trip feet allow pathways to be kept clear for pedestrian access.

Features:

- Incredible strength and durability.
- Free standing with 360° swivel feet.
- Moulded in orange as standard.
- Coloured feet if desired.
- Barrier to barrier connection is quick and easy to use.
- Company identification can be embossed.
- Manufactured in High Density Polyethylene.
- Can be used with barrier boards.
- Available as a Hook & Eye version (Gate).

Standards:

- Conforms to requirements of **BSEN8442**
- Reflectivity requirements of **BSEN12899-1**
- Chapter 8 - The Traffic Signs Manual
- The Red Book 2013
- Traffic Signs Regulations & General Directions



Anti-Trip Foot Gate Version

Size 1	
Height	1000 mm
Depth	50 mm
Width	1000 mm
Weight	9.60 kg
Size 2	
Height	1000 mm
Depth	50 mm
Width	1250 mm
Weight	10.15 kg

*All weights are approximate



The information given on these sheets is typical of the product depicted it must not be interpreted as a guarantee of individual product performance and/or characteristics. We reserve the right to alter specifications and designs without prior notice. All measurements are in millimetres (mm)





Utility Barrier

Description:

The Utility Barrier is the ideal solution for any variety of Utility Works. Completely manufactured within the UK at the Melba Swintex factory, with its unique and protected D-Hinge™ system, the Barrier becomes incredibly stable. The Utility Barrier and D-Hinge™ have been designed to connect to the existing metal gate systems, and other plastic Barriers already on the market. The upper area of the Utility Barrier has been designed with an increased area for Highly Reflective material, making the Barrier fully equipped for the European market.

Features:

- Manufactured by Melba Swintex in the UK.
- Incredibly stable thanks to the D-Hinge™ & D-Clip™.
- Facility for a 600 x 450 courtesy sign.
- Corporate branding can be embossed.
- Compatible with existing barriers.
- Higher reflective area.
- Deep channels to prevent collection of rainwater.
- Incredibly durable & lightweight.
- Product stacks with itself in every orientation.



Standards:

- Reflectivity requirements of **BSEN12899-1**
- Chapter 8 - The Traffic Signs Manual
- Traffic Signs Regulations & General Directions



Height:	1000 mm
Panel Width:	750 mm or 1000 mm
Panel Depth:	20 mm
Panel Weight:	2.70 kg & 3.60 kg

*All weights are approximate

The information given on these sheets is typical of the product depicted it must not be interpreted as a guarantee of individual product performance and/or characteristics. We reserve the right to alter specifications and designs without prior notice. All measurements are in millimetres (mm)



The Postman

Description:

The Postman takes the current temporary barrier system within utility works and updates it by implementing a range of innovative features & increasing its strength and durability.

Features:

- Post is high enough so that a temporary lamp can be attached into the top and the planks can be removed.
- Posts & Planks can be manufactured in corporate colours to suit.
- Bases can be colour coated.
- Posts, Planks & Bases can have corporate brands embossed onto.
- Planks are extremely durable and can last 8 times longer than uPVC Planks.
- Base fits securely over the post and can also be doubled up.
- All three products are compatible with older systems.

Standards:

- Conforms to requirements of **BSEN8442**
- Reflectivity requirements of **BSEN12899-1**
- Chapter 8 - The Traffic Signs Manual
- The Red Book 2013
- Traffic Signs Regulations & General Directions

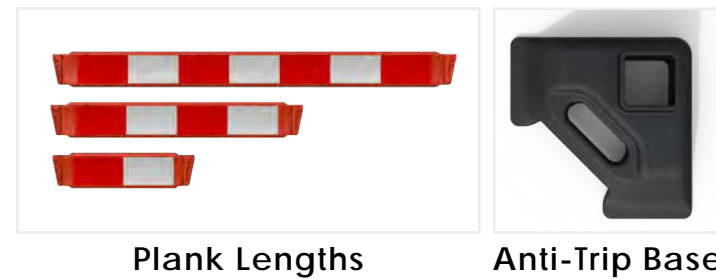

Overall Height:	1170 mm
Overall Weight:	7.95 kg
Base Width:	450 mm
Plank Width:	0.50 m, 1.25 m, 2.00 m
Post Width:	100 mm
Plank Depth:	30 mm
Base Depth:	450 mm
Post Depth:	100 mm

*All weights are approximate



The information given on these sheets is typical of the product depicted it must not be interpreted as a guarantee of individual product performance and/or characteristics. We reserve the right to alter specifications and designs without prior notice. All measurements are in millimetres (mm)



Barrier Colours

It is now possible to preview the range of Melba Swintex barriers in any desired colour.

Using the online Barrier Colour tool, a barrier can be selected, along with the range of feet, a colour can easily be applied to each.

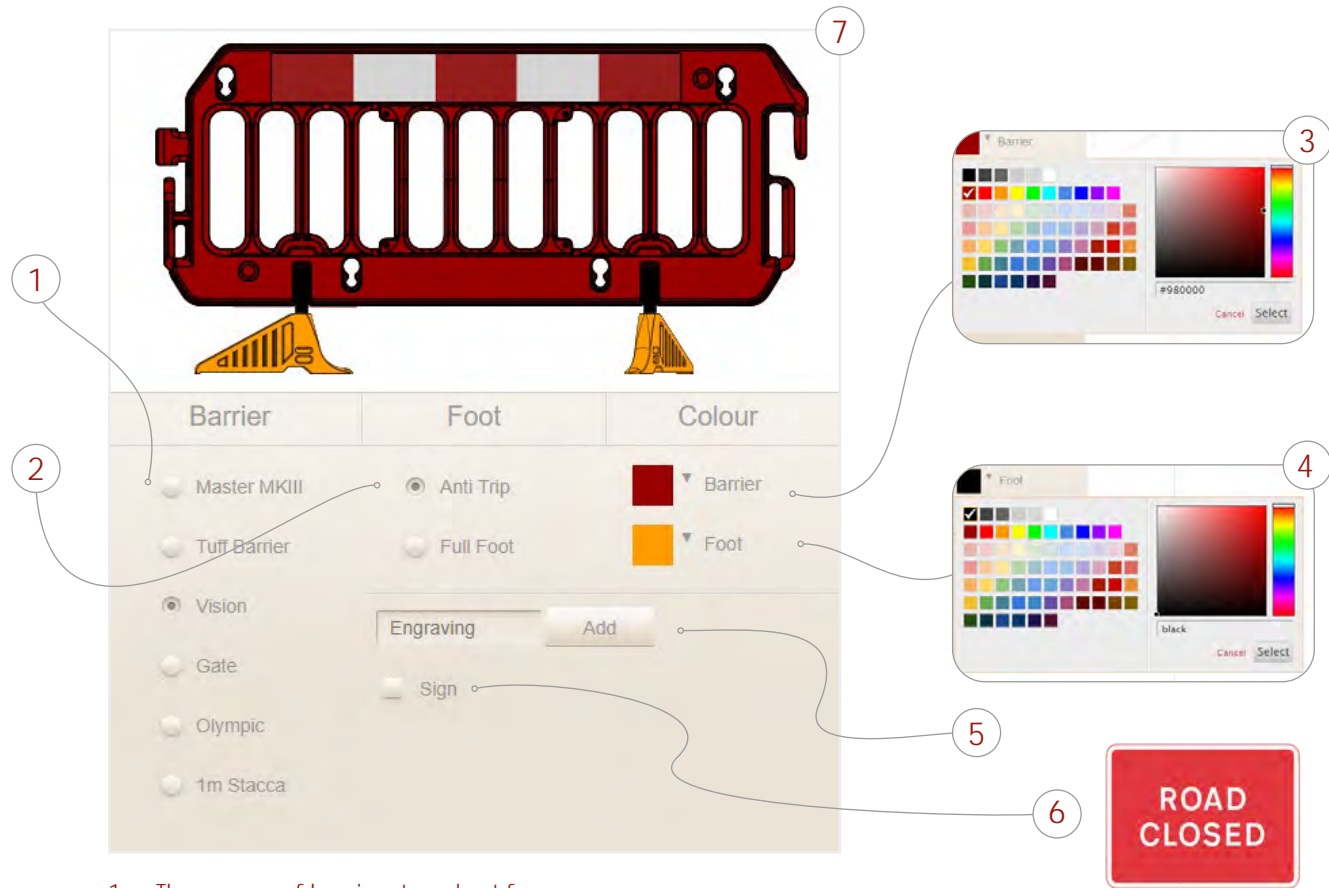

1. The range of barriers to select from.
2. Choices for the range of barrier feet.
3. Choose any colour for the Barrier.
4. Choose any colour for the feet.
5. Add any additional engraving.
6. Add a central sign.
7. Preview how the barrier will look.

Test it out now at:
<https://www.melbaswintex.com>



Separators

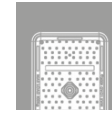

Road Runner

Description:

The Road Runner is a self-weighted Delineator which does not require filling of sand or water. Wheels allow for easy manoeuvring, and a tail that allows for a quick connection.

Features:

- Weighs 22.5 kg, water or sand are not required.
- Pin on tail interlocks with underside of adjoining separator to create lanes.
- Wheels for easy movement.
- Robust - able to withstand high impacts
- Superb wind resistance.
- Fork lift slots on the bottom.
- 25 per pallet.
- Top manufactured from Virgin HDPE.
- Base manufactured from recycled PVC.
- By weight 92% recycled material.
- Available in Red and White.



Interlocking



Wheels



Transport

Please see the back for Wind Resistance



Height:	600 mm
Width:	1140 mm
Depth:	300 mm
Weight:	22.50 kg

*All weights are approximate

The information given on these sheets is typical of the product depicted it must not be interpreted as a guarantee of individual product performance and/or characteristics. We reserve the right to alter specifications and designs without prior notice. All measurements are in millimetres (mm)



HOG600

Description:

A sturdy and long-lasting Water Separator that has the capacity to hold over 55 litres of water. Incorporating a hook and eye system which provides a simple and prompt installation, with the facility to increase its height with the addition of a top panel Fence.

Features:

- Designed to be secure and completely anti-trip.
- Hook and eye connection for quick and simple deployment.
- Capacity to over 55 litres.
- Stable & Secure stacking.
- Angular freedom of over 235°.
- Fork lift entry for ease of movement.
- Can be emptied from the top.
- Compatible with other Water Filled systems.
- Facility for a top panel Fence.
- Can be embossed with corporate logo.
- Manufactured from HDPE
- 100% recyclable.

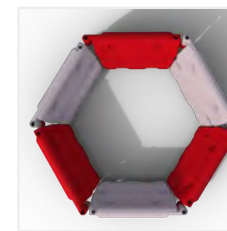

Looped

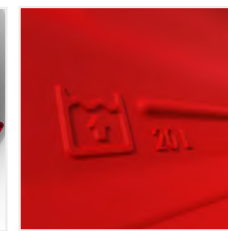

Fill Indicator



Run



Height:	560 mm
Width:	1130 mm
Depth:	400 mm
Weight Empty:	5.5 kg
Weight Filled:	60 kg

*All weights are approximate

The information given on these sheets is typical of the product depicted it must not be interpreted as a guarantee of individual product performance and/or characteristics. We reserve the right to alter specifications and designs without prior notice. All measurements are in millimetres (mm)



Buddha Barrier

Description:

The Buddha Barrier is a uniquely designed, completely anti-trip Water Filled Separator. At 800 mm in height, it creates a safer environment for pedestrians over traditional Water Filled Separators, as well as this, the Buddha Barrier can be fitted with the DoubleTop that creates a barrier over 1.8 m in height.

Features:

- Can be used either way due to Dual Reflective.
- Completely Anti-Trip.
- Connect to one another using the S-Clip.
- Concave area can be used for spoil placement.
- Two can be faced together over exposed holes & damaged manhole covers.
- Capacity to hold 22 litres bringing the complete weight to 27.2 kg.
- Large Corporate Branding area of 300 x 170 mm.
- Overflow indication prevents overfilling.
- Manufactured from HDPE & 100% recyclable.
- Can be positioned at over 270°.
- Hole & Bung can be supplied if required.
- Patented Product.



Top Deck

Over 270°

Closed

Standards:

- Reflectivity requirements of **BSEN12899-1**

Please see the back for Wind Resistance



Height:	800 mm
Width:	1040 mm
Depth:	280 mm
Weight Empty:	5.5 kg
Weight Filled:	27.5 kg
Pal. Quantity:	22

*All weights are approximate

The information given on these sheets is typical of the product depicted it must not be interpreted as a guarantee of individual product performance and/or characteristics. We reserve the right to alter specifications and designs without prior notice. All measurements are in millimetres (mm)



WonderWall™

Description:

The WonderWall™ is a heavy duty, enhanced Barrier system. The robust Barrier gives stability in high winds without the need for extra ballast. It creates a safer working environment when Barrier is deployed near the road side, or excavations on site. Can be moved with ease by one person, and can be moved via Fork-lift truck when the Bases are stacked.

Features:

- Pedestrian & Plant WonderDoor™ can be used.
- The WonderDoor™ system can be created using the Melba Swintex S-Clip, as well as connection to existing Barrier systems.
- Embossing with corporate branding on both the Base and Top.
- Tops and Bases can be coloured coded for corporate identity .
- Holes in base for Fork lift entry.
- Location holes for a 600 x 450 Courtesy Sign, & Lamp bracket.
- Bases can stack with one another.
- Reflective area for high visibility.
- Compatible with existing systems.
- Facility to take a double decked system.
- 21 pieces each to a pallet.



Connection WonderDoor™ Embossing

Standards:

- Reflectivity requirements of **BSEN12899-1**
- Chapter 8 - The Traffic Signs Manual
- Traffic Signs Regulations & General Directions

Please see the back for Wind Resistance



Height:	1000 mm
Width:	1140 mm
Barrier Depth:	50 mm
Base Depth:	500 mm
Weight:	25 kg

*All weights are approximate

The information given on these sheets is typical of the product depicted it must not be interpreted as a guarantee of individual product performance and/or characteristics. We reserve the right to alter specifications and designs without prior notice. All measurements are in millimetres (mm)



Mini DoubleTop

Description:

The Mini-DoubleTop is a smaller variation of the DoubleTop, designed to locate into various barrier systems in order to increase their height. The robust design with additional reflective panels makes the HOG600 Chapter 8 compliant, whilst also providing a sound and stable setup ensuring public and workforce safety.

Features:

- Hook and Eye system connection for quick and secure deployment.
- No additional brackets or tools required for connection.
- Stays connected on uneven surfaces.
- Corporate logo can be embossed.
- Reflective can be added.
- 100% Recyclable
- No sharp edges.
- Reduced theft – not Metal.
- Manufactured from HDPE.
- Manufactured in the UK.

Standards:

- Reflectivity requirements of **BSEN12899-1**
- Chapter 8 - The Traffic Signs Manual



HOG600

Buddha

WonderWall

Width:	1115 mm
Height:	535 mm (Installed) 700 mm (Overall)
Depth:	50 mm
Weight:	3 kg

*All weights are approximate

The information given on these sheets is typical of the product depicted it must not be interpreted as a guarantee of individual product performance and/or characteristics. We reserve the right to alter specifications and designs without prior notice. All measurements are in millimetres (mm)



DoubleTop

Description:

The DoubleTop is a multi-use barrier top designed for use on the WonderWall™ and Buddha barrier systems. Simple Hook & Eye connectivity removes the need for additional brackets associated with conventional metal tops. The DoubleTop is lightweight, durable and has the option for reflective on the spindles.

Features:

- Highly reflective sleeves (360°) on two vertical spindles for improved visibility.
- Hook & Eye connection for easier installation.
- Red & white panels as standard.
- No sharp edges.
- Secure stacking for ease of transport.
- S-Clip option available for T-Junction connections.
- Can be embossed and/or colour coded for corporate identification.
- Manufactured from HDPE & 100% recyclable.

Standards:

- Reflectivity requirements of **BSEN12899-1**
- Chapter 8 - The Traffic Signs Manual



Buddha Compatible

WonderWall™ Boxed

T-Junction

Please see the back for Wind Resistance

Height:	1000 mm
Overall Height:	2000 mm - WonderWall™ 1800 mm - Buddha 1600 mm - HOG600
Width:	1115 mm
Depth:	60 mm
Weight:	2.8 kg

*All weights are approximate



The information given on these sheets is typical of the product depicted it must not be interpreted as a guarantee of individual product performance and/or characteristics. We reserve the right to alter specifications and designs without prior notice. All measurements are in millimetres (mm)



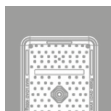
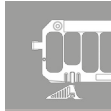

Event Management

Boss Hog

Description:

The Boss Hog is a combination of an extremely sturdy single-piece hollow body, and an incredibly heavy-duty base, which provide a completely safe and secure Events Barrier, that is a stable temporary fencing system and fit for use in busy pedestrian areas.

Features:

- Hook and Eye system connection for quick and easy deployment.
- Stays connected on uneven surfaces.
- No additional tools required for connection.
- Heavy base resilient to being forced over.
- No sharp edges.
- Reduced theft – not Metal.
- Fork lift entry on base.
- Barrier can be colour coded.
- 100% Recyclable
- Corporate logo can be embossed.
- Heavy duty single-man lift Base at 18 kg.
- Manufactured from HDPE and Recycled PVC.
- Reflective can be added to spindles.



Continuous Run



Connection



Base Connection

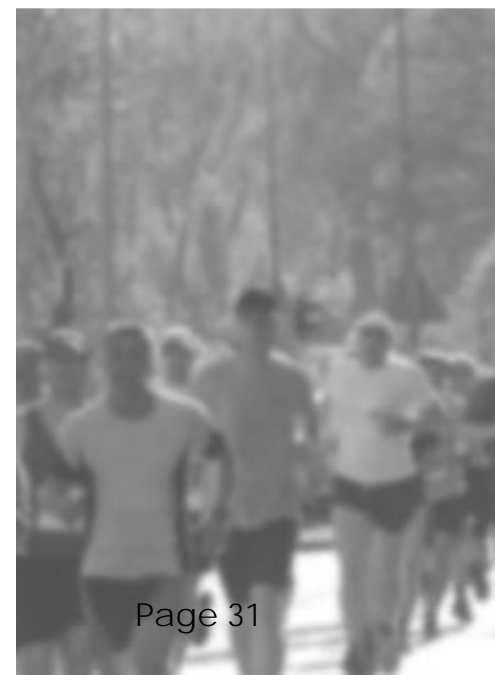

Width:	1115 mm
Height:	1250 mm
Depth:	500 mm
Weight:	21 kg

*All weights are approximate

The information given on these sheets is typical of the product depicted it must not be interpreted as a guarantee of individual product performance and/or characteristics. We reserve the right to alter specifications and designs without prior notice. All measurements are in millimetres (mm)



Boss Barrier

Description:

The Boss Barrier is an innovative approach to managing busy public areas, such as festivals, marathons, and events. The barrier is manufactured from recyclable blow moulded High Density Polyethylene, which boasts incredible durability and strength.

Features:

- Free standing with 360° swivel feet.
- Barrier can be colour coded.
- No sharp edges.
- Reduced theft.
- Completely recyclable.
- Free from screws and rivets.
- Feet can be coloured to suit.
- Barrier to barrier connection is quick and easy for use on uneven ground.
- Information sign can be attached.
- Company identification can be embossed.
- Manufactured from virgin HDPE.
- Enhanced product support using Retro-Fit braces.



Colours



Width:	2000 mm
Height:	1100 mm
Depth:	50 mm
Weight:	9.90 kg

*All weights are approximate

The information given on these sheets is typical of the product depicted it must not be interpreted as a guarantee of individual product performance and/or characteristics. We reserve the right to alter specifications and designs without prior notice. All measurements are in millimetres (mm)



Signs



Q-SIGN

THE SIGN OF DESIGN



LASER PRINTED BRANDING DOWN THE SIDE OF EACH SIGN



BACK LEG COATED TO YOUR OWN CORPORATE COLOURS



CUSTOM RAISED EMBOSING IN ALL-THROUGH YELLOW POLYMER



Q-WEIGHT

ADDITIONAL STABILITY

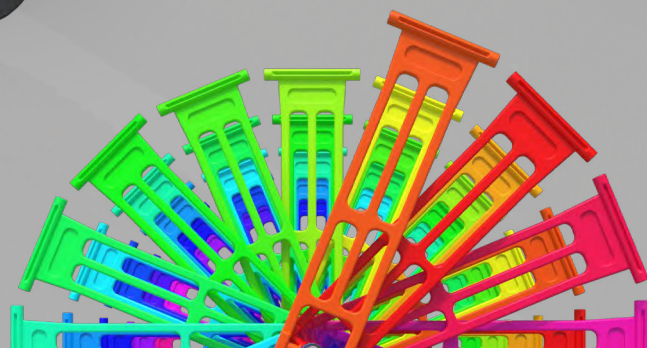
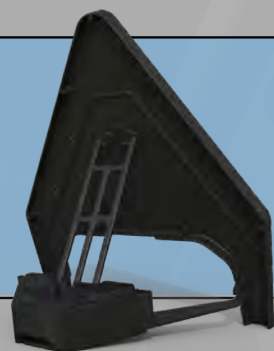

Q-Sign

Description:

The Q-Sign is the industry leader. The sign is extremely strong and durable. Manufactured from recycled Polypropylene, the sign has no metal parts. Although lightweight, the angled sign is designed to give a strong wind resistance.

Features:

- Long life due to strong and robust design.
- Does not rust.
- Manufactured from recycled Polypropylene in grey.
- Excellent weight and footprint stability.
- Non flammable.
- Easy and safe to handle.
- No sharp edges.
- Priced competitively.
- Stackable for storage and transport.
- Supplementary plate available.

Standards:

- Conforms to requirements of **BS 8442:2015**
- Chapter 8 - The Traffic Signs Manual
- The Red Book 2013
- Traffic Signs Regulations & General Directions



Please see the back for Wind Resistance

All Signs Thickness		60 mm
Combi	Size:	600 mm
	Weight:	6.20 kg
Triangle	Size:	750 mm
	Weight:	6.80 kg
Circle	Size:	750 mm
	Weight:	7.80 kg
Rectangle	Size:	600 x 450 mm
	Weight:	5.30 kg
Rectangle	Size:	1050 x 450 mm
	Weight:	6.30 kg
Rectangle	Size:	1050 x 750 mm
	Weight:	9.80 kg

*All weights are approximate



The information given on these sheets is typical of the product depicted it must not be interpreted as a guarantee of individual product performance and/or characteristics. We reserve the right to alter specifications and designs without prior notice. All measurements are in millimetres (mm)



Q-Sign Supplementary Plate

Description:

The supplementary plate is designed to fit the 750 mm Triangle Q-Sign.

Weight: 7.50 kg



All standard sign faces available.



Test out how your own customised Q-Sign would look using the Design-a-Sign tool found at:

<https://www.melbaswintex.com/qsign.php>



*Conforming to Traffic Signs Regulations & General Directions
*All weights are approximate

The information given on these sheets is typical of the product depicted it must not be interpreted as a guarantee of individual product performance and/or characteristics. We reserve the right to alter specifications and designs without prior notice. All measurements are in millimetres (mm)



Q-Frame

Description:

An industry first from Melba Swintex, an all plastic Quick Fit Frame. Implementing the revolutionary Quick-Lock fasteners that are fitted as standard. These remain securely in place allowing a quick and easy sign face installation. The frame takes 300mm and 450mm centre sign plates. Black as standard with Corporate Branding and various all-through colour options available*.

Features:

- Takes 300 mm and 450 mm centre sign faces.
- Revolutionary Nylon Quick-Lock fasteners.
- Lighter than steel = less weight in vehicle.
- Non-Metallic with no scrap value.
- Non-Conductive.
- 100% recyclable.
- Stackable - 80 to a pallet.
- Can be branded with customer logo.*
- Can be manufactured in corporate colours.*
- 25mm Secure Webbing prevents leg over splay.

Standards:

- Conforms to requirements of **BS 8442:2015**
- Chapter 8 - The Traffic Signs Manual
- The Red Book 2013
- Traffic Signs Regulations & General Directions

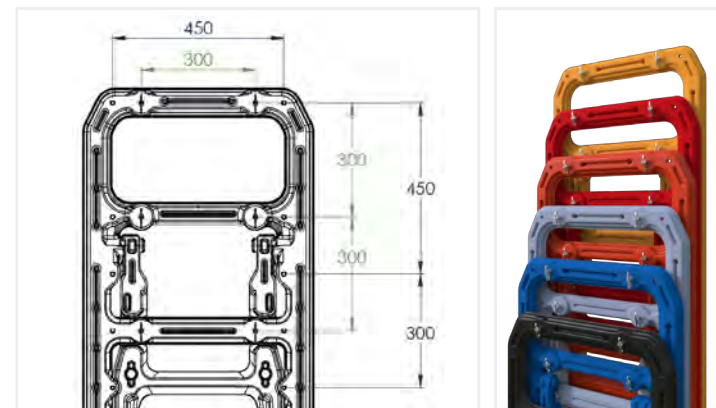

Height:	1505 mm
Installation Height:	1400 mm
Width:	605 mm
Depth:	65 mm
Weight:	5 kg

*Min. Order Quantity Applies
*All weights are approximate



The information given on these sheets is typical of the product depicted it must not be interpreted as a guarantee of individual product performance and/or characteristics. We reserve the right to alter specifications and designs without prior notice. All measurements are in millimetres (mm)



Hangman

Description:

This fast deployable all plastic sign was designed to place on to a traffic cone thus saving space and weight for the user.



Circle



Triangle



Back



Standards:

- Conforms to requirements of **BSEN8442**
- Chapter 8 - The Traffic Signs Manual
- The Red Book 2013
- Traffic Signs Regulations & General Directions

Triangle	Size:	600 mm
	Weight:	0.70 kg
Triangle	Size:	750 mm
	Weight:	1.15 kg
Circle	Size:	600 mm
	Weight:	0.95 kg
Circle	Size:	750 mm
	Weight:	1.40 kg
Rectangle	Size:	600 x 450 mm
	Weight:	0.80 kg

*All weights are approximate



The information given on these sheets is typical of the product depicted it must not be interpreted as a guarantee of individual product performance and/or characteristics. We reserve the right to alter specifications and designs without prior notice. All measurements are in millimetres (mm)



Footway Boards



Hawk Tuff Trench

Description:

The Hawk Tuff Trench is the first blow moulded trench cover on the market. Designed and manufactured in the UK, and made with Utility and Highway contractors in mind. The cover can withstand over 400 kg loads, and has a high impact resistance. Strong, durable and able to protect open areas on the footpath. Manufactured from 100% virgin material and 100% recyclable.

Features:

- 4 fixing holes to bolt to the ground.
- Can be fitted with reflective bands.
- Anti-Slip pattern.
- Designed with Anti-Trip edges.
- Able to withstand over 400 kgs.
- Handles for easy lifting.
- Single man lift.
- Corporate logos can be embossed onto the top of Tuff Trench cover.*
- Manufactured in High Density Polyethylene.
- Manufactured in yellow for high visibility, can be bespoke coloured.*
- Tuff Trench is 100% Recyclable
- High impact resistance (Does not shatter).

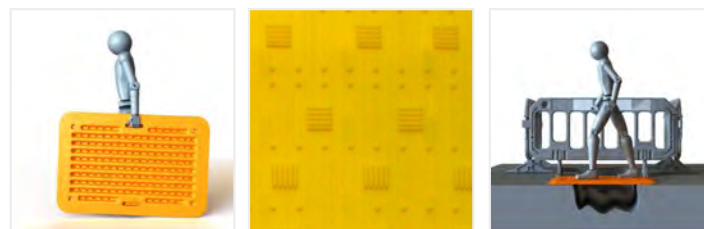

Handles

Anti-Slip

In Use

Standards:

- Conforms to **National Grid T/SP/E/42**
- Conforms to **HAUC Advice Note No. 2018/01**
- The Red Book 2013
- Conforms to slip resistance of **BS 7976: Part 2**

Width:	800 mm
Height:	40 mm
Depth:	1200 mm
Weight:	8 kg



*Minimum run applies
*All weights are approximate

The information given on these sheets is typical of the product depicted it must not be interpreted as a guarantee of individual product performance and/or characteristics. We reserve the right to alter specifications and designs without prior notice. All measurements are in millimetres (mm)



Hawk Tuff Tread

Description:

The Hawk Tuff Tread is a single-man lift Trench Cover which boasts great strength, durability, and a high-in-traction tread pattern that prevents free movement when in situ. The cover consists of 4 PVC segments that are manufactured from 100% recycled material that can easily be replaced when damaged.

Features:

- PVC Skirt for increased grip.
- PVC Skirt can be retro-fitted.
- 4 fixing holes for bolting to the ground.
- Anti-Slip pattern.
- Designed with Anti-Trip edges.
- Able to withstand over 400 kgs on a spot load.
- Built in handles for easy lifting.
- Single man lift.
- Corporate logos can be embossed*
- Manufactured in High Density Polyethylene & recycled PVC.
- Manufactured in yellow for high visibility, corporate colours available*
- 100% Recyclable.
- 60 per pallet.

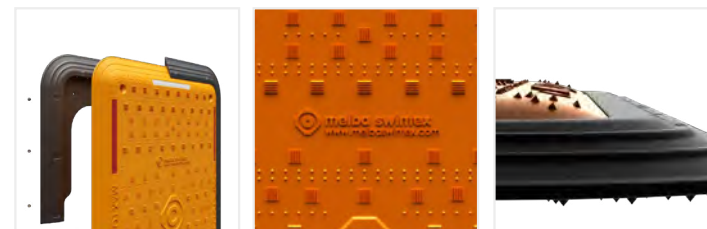

Construction

Embossing

Grip Detail

Standards:

- Conforms to **National Grid T/SP/E/42**
- Conforms to **HAUC Advice Note No. 2018/01**
- The Red Book 2013
- Conforms to slip resistance of **BS 7976: Part 2**

Width:	890 mm
Height:	48 mm
Depth:	1290 mm
Weight:	22.55 kg



*Minimum run applies

The information given on these sheets is typical of the product depicted it must not be interpreted as a guarantee of individual product performance and/or characteristics. We reserve the right to alter specifications and designs without prior notice. All measurements are in millimetres (mm)



Driveway Board

Description:

The Driveway Board is the first blow moulded board of its type. Tested under strict laboratory conditions, the board has been approved to the current HAUC specification. As well as its great strength and durability, the board is also 100% recyclable. The board provides non-slip care-free access for up to 700 mm wide trenches and can also be bolted down for long term projects and added security. It can also be colour coded and embossed for reduced theft.

Features:

- PVC Skirt for increased grip
- Supports a 4 tonne vehicle
- Able to withstand over a 1 tonne spot load
- Directional arrows for ease of installation
- 4 fixing holes
- Corporate logos can be embossed*
- Can be colour coded with corporate colours*
- 100% Recyclable
- Built in handles for easy lifting
- Anti-Slip pattern & Anti-Trip edges
- Manufactured in High Density Polyethylene & recycled PVC
- Manufactured in yellow for high visibility

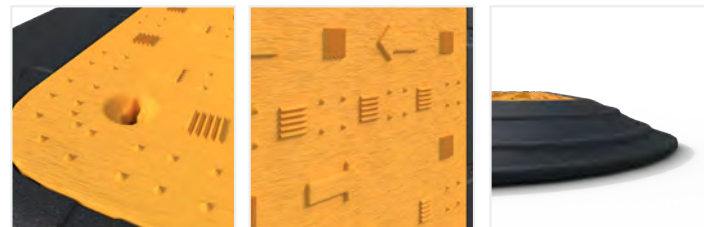
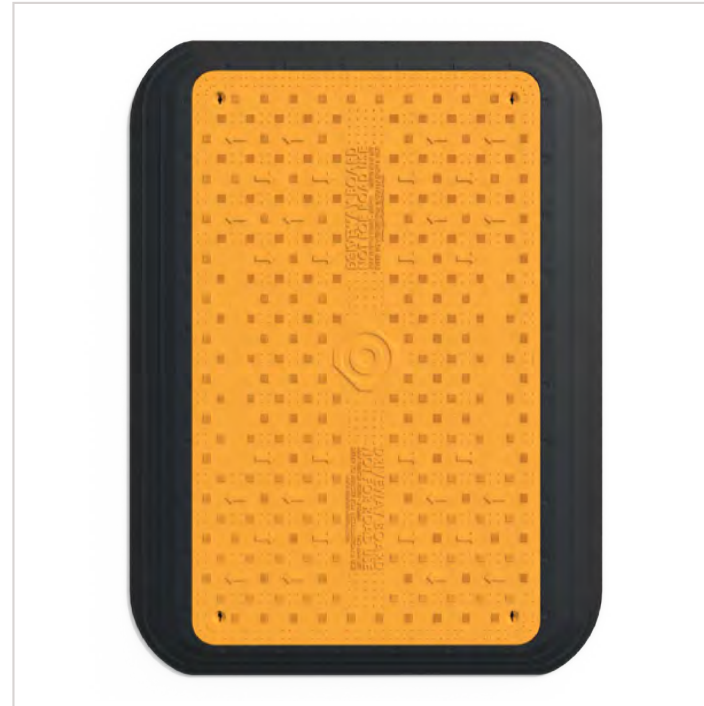

Bolt Holes

Anti-Slip

Tread

Standards:

- Conforms to **National Grid T/SP/E/42**
- Conforms to **HAUC Advice Note No. 2018/01**
- The Red Book 2013
- Conforms to slip resistance of **BS 7976: Part 2**

Width:	1600 mm
Height:	48 mm
Depth:	1200 mm
Weight:	40 kg

*All weights are approximate



The information given on these sheets is typical of the product depicted it must not be interpreted as a guarantee of individual product performance and/or characteristics. We reserve the right to alter specifications and designs without prior notice. All measurements are in millimetres (mm)



Cable Covers



Cable Covers

Description:

Cable covers are hollow, rotationally moulded product, which are placed over exposed cable.

Features:

- Designed to provide a highly visible warning to the public that there is a high voltage hazard, to keep left, or a live cable hazard.
- Each cover features a sand ballasted base for added stability.



Live Cable

Keep Left

High Voltage



Height:	1170 mm
Base:	710 mm x 710 mm Hexagonal
Weight:	17.20 kg (Sand Ballasted)

*All weights are approximate

The information given on these sheets is typical of the product depicted it must not be interpreted as a guarantee of individual product performance and/or characteristics. We reserve the right to alter specifications and designs without prior notice. All measurements are in millimetres (mm)



Cylinders



Swinbac

Description:

A self-righting Cylinder with little to no maintenance required. Can be supplied with anchor-bolts or adhesive pads to secure to the ground.

Features:

- Manufactured from recyclable HDPE.
- Variety of colours.
- Lightweight.
- Tough and durable.
- Easy to install.
- Base fixes to ground.
- Self rights itself after a collision.

Adhesive Pads:

Thickness: 2 mm
 Diameter: 260 mm
 Max Temperature: 30 °C
 Min Temperature: 5 °C

Sleeve:

- Micro Prismatic Retro-Reflective PVC Sheeting.

Standards:

- Conforms to requirements of **BSEN13422**
- Chapter 8 - The Traffic Signs Manual
- The Red Book 2013
- Traffic Signs Regulations & General Directions

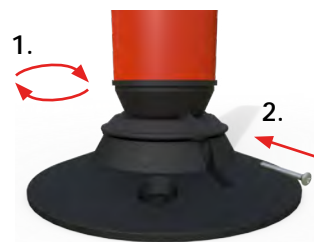

Installation:

1. Locate into Base and twist 90° to fit.
2. Using a self-tapping wood screw at over 35 mm thread, secure the Base to the Cylinder through the slot on the Base.



	Size 1	Size 2	Size 3	Base
Height:	460 mm	750 mm	1000 mm	50 mm
Weight:	0.50 kg	0.70 kg	0.90 kg	1.40 kg
Diameter:	103 mm	103 mm	103 mm	275 mm

*All weights are approximate

Flexi Cylinder

Description:

A self-righting Cylinder with little to no maintenance required. Can be supplied with anchor-bolts or adhesive pads to secure to the ground.

Features:

- Flexible LDPE.
- Variety of colours.
- Lightweight.
- Tough and durable.
- Easy to install.
- Base fixes to ground.
- Self rights itself after a collision.

Adhesive Pads:

- Thickness: 2 mm
- Diameter: 260 mm
- Max Temperature: 30 °C
- Min Temperature: 5 °C

Standards:

- Conforms to requirements of **BSEN13422**
- Chapter 8 - The Traffic Signs Manual
- The Red Book 2013
- Traffic Signs Regulations & General Directions



Size 1	Size 2	Size 3	
Height:	1000 mm	750 mm	460 mm
Weight:	0.90 kg	0.70 kg	0.50 kg
Cats Eye Base			
Height:	50 mm		
Weight:	1.40 kg		
Diameter:	275 mm		



*All weights are approximate

Kingpin

Description:

The Kingpin is a lightweight cylinder that is perfect for managing the direction of traffic. Manufactured to be tough and durable, with little to no maintenance. Can be supplied with anchor-bolts or adhesive pads to secure to the ground.

Features:

- Manufactured from HDPE.
- Variety of colours.
- Lightweight.
- Tough and durable.
- Easy to install.
- Base fixes to ground.

Adhesive Pads:

Thickness: 2 mm
Diameter: 260 mm
Max Temperature: 30 °C
Min Temperature: 5 °C

Sleeve:

- Micro Prismatic Retro-Reflective PVC Sheeting.

Standards:

- Conforms to requirements of **BSEN13422**
- Chapter 8 - The Traffic Signs Manual
- The Red Book 2013
- Traffic Signs Regulations & General Directions



Size 1

Size 2

Size 3

Size 1	Height:	1000 mm
	Weight:	0.90 kg
Size 2	Height:	750 mm
	Weight:	0.70 kg
Size 3	Height:	460 mm
	Weight:	0.50 kg
Cats Eye Base	Height:	50 mm
	Weight:	1.40 kg
	Diameter:	275 mm

*All weights are approximate



The information given on these sheets is typical of the product depicted it must not be interpreted as a guarantee of individual product performance and/or characteristics. We reserve the right to alter specifications and designs without prior notice. All measurements are in millimetres (mm)



Ariane Twist-Lock

Description:

Derived from the Ariane XXI, this new version implements the twist-lock mechanism that can be seen on the existing Cylinder range which allows the Cylinder to be locked into the Melba Swintex Cats-Eye Base. Handles have been implemented to allow greater grip for when attaching the Cylinder to its base.

Features:

- Available in a variety of colours.
- Lightweight and durable.
- Easy to install.
- Base fixes to ground.
- Handle grips for easy twist to lock manoeuvre.
- Corporate identification can be embossed.

Standards:

- Chapter 8 - The Traffic Signs Manual
- The Red Book 2013
- Traffic Signs Regulations & General Directions
- UNE 135363

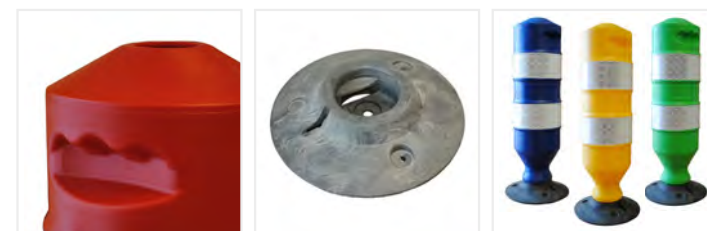

Handles

Cats Eye Base

Coloured Base

Height:	750 mm
Width:	200 mm
Weight:	1.14 kg
Base Weight:	1.4 kg

*All weights are approximate



The information given on these sheets is typical of the product depicted it must not be interpreted as a guarantee of individual product performance and/or characteristics. We reserve the right to alter specifications and designs without prior notice. All measurements are in millimetres (mm)



Phoenix

Description:

The Phoenix is a tough and durable cylinder that is manufactured to provide a strong but light-in-weight product. Handles have been implemented to allow greater grip for when attaching the Cylinder to its base.

The cylinder is available in a vast range of colours* which make it possible to reflect your brand image. As well as this, it is now also possible to emboss Company Identification onto the centre of the Cylinder. Further improving your brand identity.

Features:

- Handle grips for easy twist to lock manoeuvre.
- Corporate identification can be embossed.
- Lightweight and durable.

Standards:

- Conforms to requirements of **BSEN13422**
- Chapter 8 - The Traffic Signs Manual
- The Red Book 2013
- Traffic Signs Regulations & General Directions
- UNE 135363



Handles



Coloured



Height:	740 mm
Weight:	1.14 kg
Diameter:	200 mm

*All weights are approximate

The information given on these sheets is typical of the product depicted it must not be interpreted as a guarantee of individual product performance and/or characteristics. We reserve the right to alter specifications and designs without prior notice. All measurements are in millimetres (mm)



Ramps

Melba

Description:

The Melba Ramp enables traffic calming when required. Supplied with built in cats eyes.

Features:

- Heavy duty recyclable PVC segments.
- Range of heights and sizes to suit all speed restrictions.
- Bolt to floor fixing.
- Cats eye.
- Chequered pattern for extra grip.



50 mm Ramp

Height:	50 mm
Depth:	425 mm
Width:	500 mm
Weight:	7.80 kg
End Cap Length:	210 mm
End Cap Weight:	2.20 kg
Cats Eye:	White
Bolt Size:	M10
Recommended Speed:	15 mph

75 mm Ramp

Height:	75 mm
Depth:	465 mm
Width:	500 mm
Weight:	10.50 kg
End Cap Length:	235 mm
End Cap Weight:	3.50 kg
Cats Eye:	White
Bolt Size:	M10
Recommended Speed:	10 mph

*All weights are approximate



The information given on these sheets is typical of the product depicted it must not be interpreted as a guarantee of individual product performance and/or characteristics. We reserve the right to alter specifications and designs without prior notice. All measurements are in millimetres (mm)



Kerb Buddy

Description:

The Kerb Buddy is a blow moulded Footway Ramp manufactured from High Density Polyethylene. The Kerb Buddy boasts great strength and durability, and provides easy access to varied street level utility works. A highly effective Anti-slip pattern ensures safety and comfort.

Features:

- 4 fixing holes. Can be bolted to the ground.
- Efficient anti-slip pattern.
- Low edges for anti-trip.
- High rise sides to prevent falls.
- 180° Stacking.
- Able to withstand over 250Kgs.
- Handles for easy lifting.
- Company identification can be embossed.
- Manufactured in High Density Polyethylene.
- Manufactured in yellow as standard, but can be coloured to suit.
- Product can be recycled.
- High impact resistance (Does not shatter).

Standards:

- Conforms to **National Grid T/SP/E/42**
- A Code of Practice 2013



Embossing

Anti-Slip

Stacking

The Ramp is designed to sit comfortably when placed on various kerb heights. Min 75mm, Max 125mm.



Width:	1200mm
Wall Height:	90mm
Depth:	985mm
Weight:	8Kg

*All weights are approximate



The information given on these sheets is typical of the product depicted it must not be interpreted as a guarantee of individual product performance and/or characteristics. We reserve the right to alter specifications and designs without prior notice. All measurements are in millimetres (mm)



RightRamp

Description:

Designed in conjunction with the University of East Anglia, led by Dr Katherine Deane BSc PhD - Senior Lecturer in Research, and her team.

A uniquely designed ramp focused for people of varying abilities to overcome the issues that all current wheelchair ramps have. Extremely stable when in use, with excellent grip on its surface in all conditions. A consistent ramp angle allows multiple angle entry/exit.

Features:

- Designed to lay on the road to increase strength and reduce flex.
- Works to Kerb heights of 75 mm - 125 mm.
- Efficient anti-slip pattern.
- Low-rise tapping rails on each side for the visually impaired.
- Cable & rain water run off channel underneath.
- No high-rise edges that cause a trip hazard.
- Handle for ergonomic ease of lifting.
- Able to withstand over 350 kg.
- Company identification can be embossed.
- Product is 100% recyclable.



PVC Anchors Anti-Slip Handle

Standards:

- Designed to **National Grid T/SP/E/42**
- Designed to **HAUC Advice Note No. 2018/01**
- The Red Book 2013
- Conforms to slip resistance of **BS 7976: Part 2**

Width:	1199 mm
Height:	123 mm
Depth:	766 mm
Weight:	13.20 kg

*All weights are approximate

The information given on these sheets is typical of the product depicted it must not be interpreted as a guarantee of individual product performance and/or characteristics. We reserve the right to alter specifications and designs without prior notice. All measurements are in millimetres (mm)



Hose Cover

Description:

The Hose Cover is our biggest ramp that can fit over large cables and pipes. It's tough structure provides the resistance to heavy loads.

The Hose Cover is primarily manufactured in either Black or Yellow, however, other colours can be ordered. Minimum order applies.

Fixing Options:

The Hose Cover can be fixed to the ground using four bolts per part.

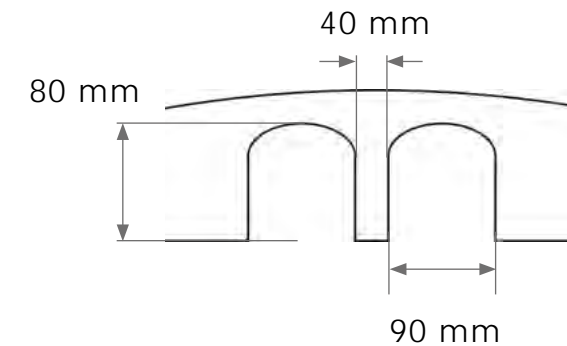

Hose Cover Fixing Bolt



Weight:	25.50 kg
Height:	100 mm
Width:	790 mm
Length:	500 mm

*All weights are approximate

The information given on these sheets is typical of the product depicted it must not be interpreted as a guarantee of individual product performance and/or characteristics. We reserve the right to alter specifications and designs without prior notice. All measurements are in millimetres (mm)



Access

Description:

A short length heavy duty ramp allowing a vast range of vehicles and similar access over low-rise curbs. Capable of sustaining high loads, the ramp can be interconnected to create a continuous run.

Features:

- Corporate identity can be embossed.
- 2 holes for bolting to the ground.
- Improved handle allows better grip when lifting.
- Open channel to the back for water or cable flow.
- Interlocking connection when used in a run.
- Sturdy grips prevents slips & falls.



In Situ



Connection



Handle



Height:	110 mm
Width:	490 mm
Weight:	7.50 kg

Not designed for Wheelchair use
*All weights are approximate

The information given on these sheets is typical of the product depicted it must not be interpreted as a guarantee of individual product performance and/or characteristics. We reserve the right to alter specifications and designs without prior notice. All measurements are in millimetres (mm)



Bases

Fence Foot MKII

Description:

A one piece compression moulded fencing foot, manufactured from recycled material. The base is completely recyclable, boasting high durability and strength. Designed to take Ø38.2 mm posts, the base ensures a secure and stable foundation for all standard fencing barricades. The product is a single man lift, with specially designed handles either side, which allows carrying with ease.

Features:

- Manufactured from recycled PVC.
- Handles at either side for easy lifting.
- One man lift.
- Two slots for Fork lift entry.
- 6 location points for fence posts.
- Bases stack with each other.



Width:	210 mm
Height:	135 mm
Length:	750 mm

18kg Multifit

Description:

The MultiFit Base combines the form of the standard fence Bases seen globally, coupled together with various hole location areas producing a multi-purpose heavy-duty Base.

Features:

- Bases stack with one another.
- Manufactured from completely recycled material.
- Can be embossed with Corporate Branding.
- Compatible with various popular guiding Beacons.
- Single-man lift at 18 kg.
- Handles either side for easy lifting.
- 14 different hole sizes.
- Forklift entry.



Width:	210 mm
Height:	170 mm
Length:	740 mm
Weight:	18 kg

*All weights are approximate

15kg Footplate

Description:

A heavy duty Base designed to take 8 different styles of product by implementing various hole sizes. Manufactured from completely recycled PVC with the potential for Corporate Branding.

Features:

- Bases stack with one another.
- 2 handle areas to easy lifting.
- Manufactured from completely recycled material.
- Can be embossed with Corporate Branding.
- Compatible with various popular guiding Beacons.
- Built in sliding latch prevents impromptu removal of straight marker.

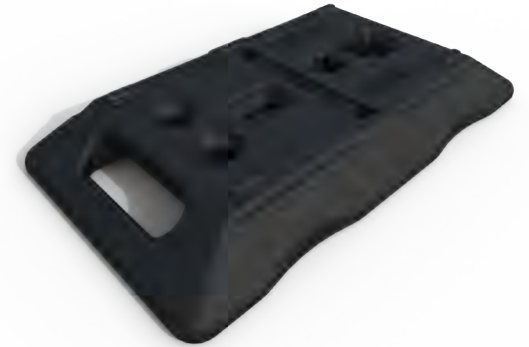

Width:	700 mm
Height:	100 mm
Depth:	395 mm
Weight:	15 kg

25kg Footplate

Description:

A heavy duty Base that supplies a 25 kg weight of stability to various applications. 5 location holes all sized respectively to corresponding posts provide secure anchorage for a variety of temporary road works.

Features:

- Bases stack with one another.
- 4 handle areas to ease lifting.
- Manufactured from completely recycled material.
- Can be embossed with Corporate Branding.
- Compatible with various popular guiding Beacon.



Width:	780 mm
Height:	120 mm
Depth:	400 mm
Weight:	25 kg

*All weights are approximate

28kg Footplate

Description:

A heavy duty Base similar to the 25kg Footplate but with a greater weight of 28kg, and the addition of a battery compartment and different sized holes.

Features:

- Bases stack with one another.
- 4 handle areas to ease lifting.
- Large Battery compartment with drainage hole.
- Manufactured from completely recycled material.
- Can be embossed with Corporate Branding.
- Compatible with various popular guiding Beacon.

Standards:

- In Accordance to TL Installation Device K1.



Width:	895 mm
Height:	130 mm
Depth:	440 mm
Weight:	28 kg

KG-Base

Description:

The KG-Base offers a heavy duty stabilisation solution at 25 kg in weight. The Base is manufactured from 100% recycled material and fits a variety of Beacon and Barrier sizes.

Features:

- Bases stack with one another.
- Heavy duty handle for ease of lifting.
- Manufactured from completely recycled material.
- Can be embossed with Corporate Branding.
- Compatible with various popular guiding Beacon.

Standards:

- In Accordance to TL Installation Device K1.



Width:	490 mm
Height:	120 mm
Length:	490 mm
Weight:	25 kg

*All weights are approximate

Stepped Weight

Description:

The Stepped Weight is a hollow blow moulded base designed to sit over the ends of Fencing Feet to act as an additional ballast. The body can be filled with a dense material such as concrete or sand.

Features:

- Weights stack for greater stability.
- Stack with other existing weights.
- Can be filled sand, concrete, or similar.
- Durable cap prevents foreign bodies entering the product.
- Ergonomic handles to provide easier handling.
- Can be embossed with corporate branding.
- Fits all common Fence Bases.

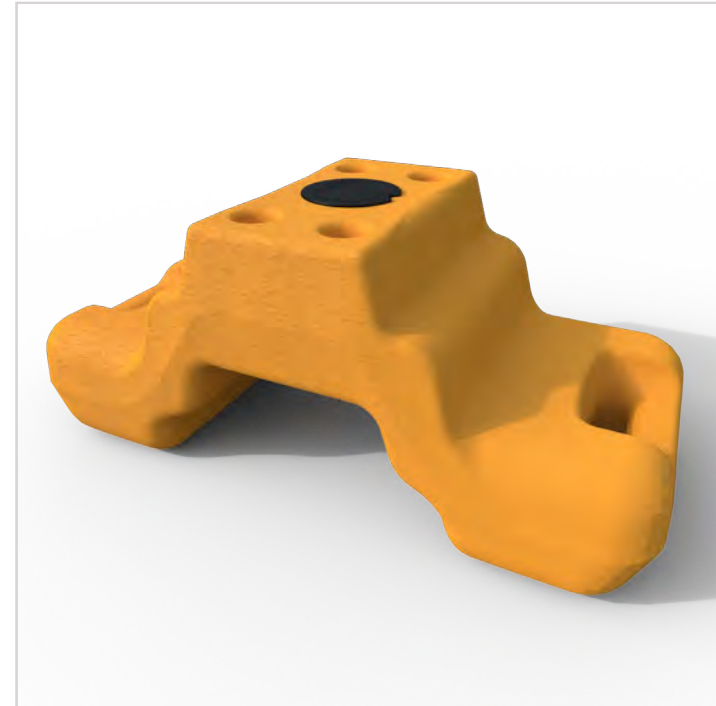

Stacked



In Use



Width:	683 mm
Height:	295 mm
Depth:	315 mm
Weight:	1.80 kg
Capacity:	20 litres

*All weights are approximate

Barrier Feet

Description:

Melba Swintex offer a collection of various feet to suit each of their barriers. All four feet are able to swivel a complete 360°.

Features:

- Foot can be coloured to suit.
- Manufactured from recycled material.
- Completely recyclable.
- 360° movement.

Standards:

- Conforms to requirements of **BSEN13422**
- Chapter 8 - The Traffic Signs Manual
- The Red Book 2013

Anti-Trip Foot

Width:	480 mm
Height:	185 mm
Depth:	50 mm
Weight:	2.10 kg



Standard Foot

Width:	660 mm
Height:	185 mm
Depth:	50 mm
Weight:	2.80 kg



Tuff-AT Foot

Width:	480 mm
Height:	185 mm
Depth:	100 mm
Weight:	4.80 kg



Tuff Foot

Width:	660 mm
Height:	185 mm
Depth:	100 mm
Weight:	5.00 kg



*All weights are approximate

Panolest Base

Description:

The Panolest Base is manufactured from 100% recycled material, and can be completely recycled. The base can take a standard Melba Swintex Cylinder, with a twist-to-lock feature, a large rectangular post, a small rectangular post, and can be used as a cable protector.

Width:	250 mm
Height:	70 mm
Length:	585 mm
Weight:	10 kg



Defiance Base

Description:

A tough and durable hexagonal base that is compatible with the entire Melba Swintex cylinder range. A simple twist-to-lock feature securely connects the cylinder to the heavy duty Base.

Width:	570 mm
Height:	820 mm
Weight:	8.70 kg



Cats Eye Base

Description:

A one piece moulded base, manufactured from recycled material. The base is completely recyclable, boasting high durability and strength. The cylinder attaches to the base via a twist-to-lock mechanism.

Diam:	270 mm
Height:	55 mm
Weight:	1.42 kg



Q-Weight

Description:

A single piece weight manufactured from 100% recycled material that is 100% recyclable. The Q-Weight provides a sound and stable loading for the entire Melba Swintex Q-Sign range that prevents movement in windy conditions.

Width:	270 mm
Height:	135 mm
Length:	462 mm
Weight:	8 kg



*All weights are approximate

Road Rock

Description:

The Road Rock is a multifunctional base and the first product of its kind that will allow a temporary pedestrian barrier to pass Class B Wind Speeds (17.6 m/s) by providing the precise weight needed each time, using two Road Rocks. When the barriers are in a boxed formation, only a single Road Rock is needed per barrier to pass Class B. Use of the Road Rock removes the need for sandbag filled ballasts, therefore resulting in a cleaner area of works.

The Road Rock has a hook and tail connection similar to that seen on the Road Runner, this makes it possible to create a continuous run and implement the base as a delineator. A cavity within the centre of the Road Rock allows a twist-to-lock cylinder to be attached.

The Road Rock has the ability to be embossed with a corporate logo, the design enables the base to stack, and at 15 kg in weight, the Road Rock is manufactured from 100% recycled PVC, which is also 100% recyclable.



Features:

- Corporate ID can be embossed.
- Interlocking for continuous runs.
- Can be coloured to suit.
- Fits all Melba Swintex Barriers.
- No sandbags required for Class B & C.
- Angular movement on interlocking.
- Can house a Traffic Cylinder.
- Can double-up as a Delineator.
- Handle for easy lifting.
- Manufactured from 100% Recycled Material.
- Product can stack.

Width:	315 mm
Height:	308 mm
Length:	500 mm
Weight:	15 kg

*All weights are approximate



Wind Speeds

A minimum of 30 kg is needed for a barrier to withstand Class B Wind Speeds (17.6 m/s). At 15 kg each, the Road Rock provides the precise weight needed, every time, to withstand these wind speeds.



Cylinder Housing

The Road Rock has the facility to fit a Melba Swintex traffic Cylinder. Incorporating the twist-to-lock mechanism regularly seen with the Cats Eye Base, it is possible to attach an existing Melba Swintex Cylinder to the Road Rock. All three sizes (50 cm, 75 cm, and 1 m) can be attached.

Interlocking Tail

Sharing similarities with the Melba Swintex Road Runner, the Road Rock has a strengthened tail that allows a run of Road Rock bases to be connected together. A curved front and back face allow angular movement, which make it possible to flow around corners and bends.



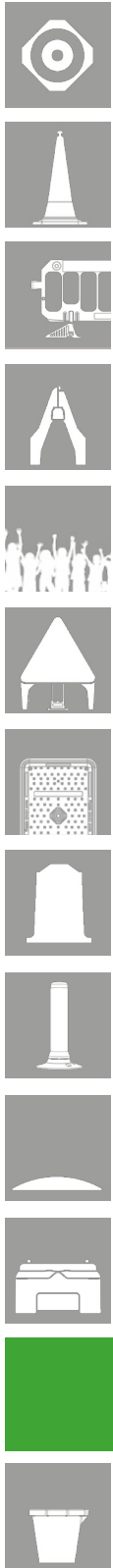

Floor Mounted

Description:

A Litter bin range that provides a large capacity for waste disposal, with various means to securing to the ground. Each bin is available in a selection of colours, with various customisation options available.



Darcy

Height: 1050 mm
Diameter: 550 mm
Capacity: 90 litres
Weight: 12.80 kg



Falcon

Height: 800 mm
Diameter: 500 mm
Capacity: 90 litres
Weight: 10.80 kg



Merlin

Height: 1000 mm
Diameter: 490 mm
Capacity: 90 litres
Weight: 12.50 kg



Pickwick

Height: 800 mm
Diameter: 450 mm
Capacity: 90 litres
Weight: 10.30 kg



Copperfield

Height: 990 mm
Diameter: 485 mm
Capacity: 90 litres
Weight: 12.40 kg



Litter Bins

*All weights are approximate

The information given on these sheets is typical of the product depicted it must not be interpreted as a guarantee of individual product performance and/or characteristics. We reserve the right to alter specifications and designs without prior notice. All measurements are in millimetres (mm)



Post Mounted

Large capacity post or wall mounted litter bin with *lockable lid. Also available in an open topped version.



Osprey	
Height:	530 mm
Diameter:	390 mm
Capacity:	40 litres
Weight:	6.55 kg



Large capacity post/wall mounted litter bin with lockable lid in traditional antique styling to compliment the Copperfield.



Nickleby	
Height:	540 mm
Diameter:	390 mm
Capacity:	40 litres
Weight:	6.70 kg



The Melba Swintex Doggy bin is specifically designed to make the disposal of dog waste as hygienic and simple as possible.



Doggy Bin	
Height:	550 mm
Diameter:	390 mm
Capacity:	40 litres
Weight:	4.80 kg



Miscellaneous



*All weights are approximate

The information given on these sheets is typical of the product depicted it must not be interpreted as a guarantee of individual product performance and/or characteristics. We reserve the right to alter specifications and designs without prior notice. All measurements are in millimetres (mm)



Bin Lid

Description:

The Bin Lid by Melba Swintex is manufactured from recycled PVC, comes with a handle, and is designed to fit an 18 inch container. A slightly domed surface prevents any collection of rain water.



Diameter: 457 mm
Weight: 2.20 kg

*All weights are approximate

The information given on these sheets is typical of the product depicted it must not be interpreted as a guarantee of individual product performance and/or characteristics. We reserve the right to alter specifications and designs without prior notice. All measurements are in millimetres (mm)



Buckets

Description:

Melba Swintex offer two extremely tough and versatile buckets, able to withstand high impacts and rough handling, which make them the perfect choice for use in the construction industry. Manufactured from recycled PVC, the bucket is available in either a 2 Gallon, or 3 Gallon capacity. Complete with a handle and spout.



2 Gallon

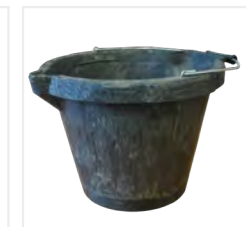

3 Gallon



2 Gallon
Diameter: 300 mm
Height: 230 mm
Weight: 2.00 kg

3 Gallon
Width: 367 mm
Height: 271.5 mm
Weight: 4.37 kg

*All weights are approximate

The information given on these sheets is typical of the product depicted it must not be interpreted as a guarantee of individual product performance and/or characteristics. We reserve the right to alter specifications and designs without prior notice. All measurements are in millimetres (mm)



Barrier Wind Resistance

Tested at 

All temporary traffic barriers must be able to withstand three different classes of wind speeds with the use of a ballast. The standard **BS 8442:2015** states the three classes as the following:

- Class A: 26.3 m/s (58 mph)**
- Class B: 17.6 m/s (39 mph)**
- Class C: 8.7 m/s (19 mph)**

Below are the results and guides as to the recommended ballast weight for each Wind Class for the Melba Swintex Barriers:

Olympic

Wind Speed Class	Speed Achieved	Rec. Ballast Weight
C	19.9 mph	0 kg
B	46.2 mph	30 kg
A	63.1 mph	80 kg
Boxed	65.4 mph	30 kg



Vision

Wind Speed Class	Speed Achieved	Rec. Ballast Weight
C	19.8 mph	0 kg
B	44.2 mph	30 kg
A	61.8 mph	90 kg
Boxed	63.4 mph	60 kg



Master (Stacca)

Wind Speed Class	Speed Achieved	Rec. Ballast Weight
C	19.3 mph	0 kg
B	44.5 mph	30 kg
A	60.3 mph	90 kg
Boxed	62.1 mph	60 kg



Tuff

Wind Speed Class	Speed Achieved	Rec. Ballast Weight
C	19.8 mph	0 kg
B	44.2 mph	30 kg
A	61.7 mph	90 kg
Boxed	63.4 mph	60 kg



Gate

Wind Speed Class	Speed Achieved	Rec. Ballast Weight
C	19.4 mph	0 kg
B	42.3 mph	30 kg
A	59.1 mph	90 kg
Boxed	59.4 mph	70 kg

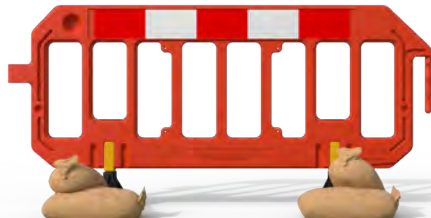

Road Runner

Wind Speed Class	Speed Achieved	Rec. Ballast Weight
C	36 mph	0 kg
B	49 mph	10 kg
A	68 mph	50 kg



WonderWall™

Wind Speed Class	Speed Achieved	Rec. Ballast Weight
C	33.2 mph	0 kg
B	47.8 mph	15 kg
A	65.6 mph	65 kg
Boxed	63.2 mph	40 kg



3 By 2 Rectangle ✔ Passed

Withstood up to 40.1 mph

Recommended Ballast Weight: **0 kg**

WonderWall™ setup in a rectangular formation and connected via the hook & peg, and using the clip on the top fence. Measuring 2mtr by 3mtr.



4 by 1 Row ✔ Passed

Withstood up to 43.3 mph

Recommended Ballast Weight: **0 kg**

WonderWall™ set out in a linear row, with an additional WonderWall attached every 4 barriers at right angles.



Buddha

Linear Row ✔ Passed

Withstood up to 31.4 mph
Recommended Ballast Weight: **0 kg**

Buddha setup in linear row.



1 Every 2 ✔ Passed

Withstood up to 40.1 mph
Recommended Ballast Weight: **0 kg**

Buddha setup in a linear row with the 'belly' into the pedestrian area, and one barrier attached every two into the excavation area.



Every Other Clammed ✔ Passed

Withstood up to 44.6 mph
Recommended Ballast Weight: **0 kg**

Buddha setup in linear row with back to back facing every other one.

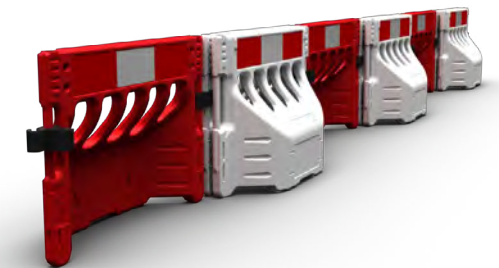

Buddha & DoubleTop ✔ Passed

Withstood up to 23.6 mph
Recommended Ballast Weight: **0 kg**

Linear row of Buddha & DoubleTop, with one Buddha perpendicular at every other 2.



HOG600

Class C

✓ Passed

Withstood over 60 mph

Recommended Ballast Weight: **0 kg**



Class B

✓ Passed

Withstood over 60 mph

Recommended Ballast Weight: **0 kg**



Class A

✓ Passed

Withstood over 60 mph

Recommended Ballast Weight: **0 kg**



Circle

✓ Passed

Withstood over 60 mph

Recommended Ballast Weight: **0 kg**

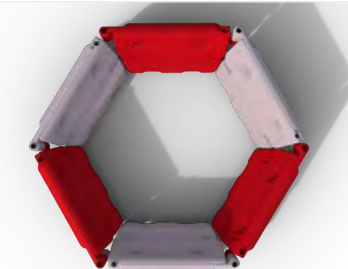

*Buddha & HOG600 water filled to maximum capacity

*All weights are approximate

Q-Sign Wind Resistance

Tested at 

All temporary signs must be able to withstand three different classes of wind speeds with the use of a ballast. The standard **BS 8442:2015** states the three classes as the following:

Class A: 26.3 m/s (58 mph)

Class B: 17.6 m/s (39 mph)

Class C: 8.7 m/s (19 mph)

Below are the results and guides as to the recommended ballast weight for each Wind Class for the Q-Sign range from Melba Swintex:

Class C

Withstood up to 26 mph

Recommended Ballast Weight: **0 kg**



Class B

Withstood up to 42 mph

Recommended Ballast Weight: **10 kg**



Class A

Withstood up to 59 mph

Recommended Ballast Weight: **30 kg**



KNOW YOUR HEIGHTS



MINI-DOUBLETOP

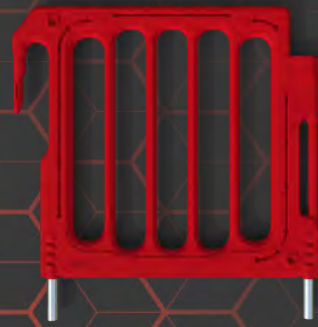

DOUBLETOP

HOG600



0.56 m

BUDDHA



0.80 m

WONDERWALL



1.00 m



